



JALADERA PORTO



Perfiles Gola



Contemporáneas

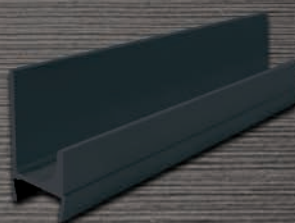

Perfiles para
Jaladeras



Botones

LÍNEA EUROPA

Jaladera Roma -----	3
Jaladera Arco -----	3
Jaladera Dublín -----	3
Jaladera Londres -----	4
Jaladera Mónaco -----	4
Jaladera Porto -----	4
Jaladera Atenas -----	4
Jaladera Lisboa -----	4
Jaladera Turín -----	4
Botón Gante -----	5
Botón Bilbao -----	5
Botón Múnich -----	5
Botón Praga -----	5
Botón Oxford -----	5

PERFILES GOLA

Perfil Gola "C" -----	6
Perfil Gola "L" -----	6

ACCESORIOS PARA PERFIL GOLA

Soporte oculto -----	6
Tapas para perfiles "C" y "L" -----	6, 7
Esquineros para perfiles "C" y "L" -----	7

PERFILES PARA JALADERA

Perfiles "Uno", "Cot" y "Sim" -----	7
Perfiles "Jet", "J", "L" y "Cot" -----	8

JALADERAS DE BARRA HUECAS CUADRADAS

Jaladera de barra huecas cuadradas negras ----	9
Jaladera de barra huecas cuadradas -----	9

JALADERAS DE BARRA HUECAS

Jaladera de barra huecas negras -----	10
Jaladera de barra huecas -----	10

JALADERAS DE BARRA

Jaladeras de barra -----	10
--------------------------	----

JALADERAS CONTEMPORÁNEAS

Jaladeras contemporáneas -----	11 - 20
--------------------------------	---------

JALADERAS DE EMBUTIR

Jaladeras de embutir -----	21
----------------------------	----

BOTONES CONTEMPORÁNEOS

Botones contemporáneos -----	21 - 25
------------------------------	---------

JALADERAS TRADICIONALES

Jaladeras tradicionales -----	26 - 28
-------------------------------	---------

BOTONES TRADICIONALES

Botones tradicionales -----	28 - 30
-----------------------------	---------

TRADICIONALES DE EMBUTIR

Tradicionales de embutir -----	30
--------------------------------	----

TORNILLOS PARA JALADERAS

Tornillos para jaladeras -----	30
--------------------------------	----

APOYO A MERCADOTECNIA

Exhibidores -----	31 - 33
-------------------	---------

Código / Página	Código / Página	Código / Página	Código / Página	Código / Página
3210 ----- 30	3826 ----- 29	3889 ----- 27	3980 ----- 29	7841 ----- 32
3211 ----- 30	3827 ----- 29	3890 ----- 30	3982 ----- 13	7842 ----- 31
3212 ----- 30	3828 ----- 27	3891 ----- 26	3983 ----- 13	7843 ----- 32
3213 ----- 30	3829 ----- 27	3892 ----- 23	3984 ----- 21	7844 ----- 32
3214 ----- 30	3830 ----- 26	3893 ----- 27	3985 ----- 21	7846 ----- 32
3217 ----- 30	3831 ----- 26	3894 ----- 29	3986 ----- 21	7847 ----- 32
3219 ----- 30	3832 ----- 29	3895 ----- 29	3987 ----- 21	7855 ----- 33
3276 ----- 7	3833 ----- 29	3896 ----- 25	3988 ----- 22	7860 ----- 31
3277 ----- 7	3834 ----- 29	3897 ----- 21	3989 ----- 24	7862 ----- 31
3278 ----- 7	3835 ----- 29	3898 ----- 4	3995 ----- 24	7863 ----- 32
3279 ----- 7	3836 ----- 28	3899 ----- 20	3999 ----- 33	7864 ----- 33
3286 ----- 6	3837 ----- 28	3900 ----- 20	4040 ----- 19	7865 ----- 33
3287 ----- 6	3838 ----- 28	3901 ----- 20	4041 ----- 19	7867 ----- 33
3288 ----- 8	3839 ----- 28	3902 ----- 20	4043 ----- 23	7875 ----- 33
3289 ----- 8	3840 ----- 27	3903 ----- 20	4048 ----- 19	7981 ----- 10
3290 ----- 8	3841 ----- 27	3904 ----- 21	4049 ----- 19	7982 ----- 20
3291 ----- 8	3842 ----- 27	3905 ----- 21	4227 ----- 28	7983 ----- 3
3565 ----- 21	3843 ----- 27	3906 ----- 15	4228 ----- 28	7984 ----- 20
3566 ----- 21	3844 ----- 23	3907 ----- 15	4229 ----- 28	7985 ----- 3
3567 ----- 21	3845 ----- 25	3908 ----- 15	4231 ----- 28	7986 ----- 20
3741 ----- 6	3846 ----- 25	3910 ----- 15	4237 ----- 28	7987 ----- 3
3742 ----- 6	3847 ----- 25	3911 ----- 15	4239 ----- 28	7988 ----- 20
3743 ----- 6	3848 ----- 25	3912 ----- 15	4240 ----- 4	7989 ----- 3
3781 ----- 11	3849 ----- 30	3913 ----- 15	4241 ----- 4	7990 ----- 10
3784 ----- 14	3850 ----- 23	3914 ----- 15	4242 ----- 3	7991 ----- 10
3785 ----- 14	3851 ----- 23	3915 ----- 22	4243 ----- 3	7992 ----- 10
3786 ----- 14	3852 ----- 24	3916 ----- 17	4244 ----- 4	7993 ----- 10
3787 ----- 14	3853 ----- 24	3917 ----- 15	4245 ----- 4	7994 ----- 10
3788 ----- 11	3854 ----- 24	3918 ----- 18	4246 ----- 5	7995 ----- 10
3789 ----- 11	3855 ----- 24	3919 ----- 3	4247 ----- 28	7996 ----- 10
3793 ----- 11	3856 ----- 4	3920 ----- 3	4248 ----- 5	7997 ----- 10
3794 ----- 12	3857 ----- 16	3921 ----- 4	4249 ----- 5	7998 ----- 10
3795 ----- 12	3858 ----- 10	3922 ----- 15	4251 ----- 28	7999 ----- 10
3796 ----- 12	3859 ----- 10	3923 ----- 17	4252 ----- 4	9003 ----- 3
3797 ----- 12	3860 ----- 10	3924 ----- 4	4253 ----- 4	9005 ----- 3
3798 ----- 12	3861 ----- 10	3925 ----- 16	4255 ----- 5	79905 ----- 10
3799 ----- 12	3862 ----- 26	3926 ----- 18	4256 ----- 5	79906 ----- 9
3800 ----- 19	3863 ----- 25	3927 ----- 18	4257 ----- 5	79907 ----- 10
3801 ----- 19	3864 ----- 19	3928 ----- 13	4258 ----- 5	79908 ----- 9
3802 ----- 23	3865 ----- 17	3930 ----- 15	4259 ----- 5	79915 ----- 10
3803 ----- 23	3866 ----- 26	3931 ----- 15	4260 ----- 30	79916 ----- 9
3804 ----- 19	3867 ----- 16	3933 ----- 16	4261 ----- 30	79917 ----- 10
3805 ----- 19	3868 ----- 25	3934 ----- 22	4269 ----- 30	79918 ----- 9
3806 ----- 20	3869 ----- 24	3935 ----- 5	4270 ----- 5	79925 ----- 10
3807 ----- 20	3870 ----- 19	3936 ----- 22	4271 ----- 5	79926 ----- 9
3808 ----- 19	3871 ----- 26	3937 ----- 22	4272 ----- 4	79935 ----- 10
3809 ----- 19	3872 ----- 20	3938 ----- 22	4273 ----- 4	79936 ----- 9
3810 ----- 24	3873 ----- 19	3939 ----- 23	4274 ----- 4	79945 ----- 10
3811 ----- 24	3874 ----- 17	3940 ----- 14	4276 ----- 7	79946 ----- 9
3812 ----- 25	3875 ----- 20	3942 ----- 14	4277 ----- 7	79955 ----- 10
3813 ----- 25	3876 ----- 19	3943 ----- 14	4278 ----- 7	79956 ----- 9
3814 ----- 24	3877 ----- 16	3944 ----- 16	4279 ----- 7	79965 ----- 10
3815 ----- 24	3878 ----- 16	3945 ----- 8	4280 ----- 8	79966 ----- 9
3816 ----- 23	3879 ----- 17	3946 ----- 7	4281 ----- 8	79975 ----- 10
3817 ----- 23	3880 ----- 18	3947 ----- 7	4286 ----- 6	79976 ----- 9
3818 ----- 25	3881 ----- 25	3948 ----- 7	4287 ----- 6	79985 ----- 10
3819 ----- 25	3882 ----- 17	3949 ----- 7	7101 ----- 10	79986 ----- 9
3820 ----- 24	3883 ----- 18	3974 ----- 12	7102 ----- 10	79987 ----- 10
3821 ----- 24	3884 ----- 16	3975 ----- 12	7103 ----- 10	79988 ----- 9
3822 ----- 23	3885 ----- 28	3976 ----- 13	7104 ----- 10	79995 ----- 10
3823 ----- 23	3886 ----- 27	3977 ----- 13	7105 ----- 10	79996 ----- 9
3824 ----- 29	3887 ----- 30	3978 ----- 13	7106 ----- 10	79997 ----- 10
3825 ----- 29	3888 ----- 27	3979 ----- 13	7107 ----- 10	79998 ----- 9



LÍNEA EUROPA

JALADERA ROMA



● **NUEVO ARTÍCULO**

Código	Longitud (mm)	Altura (mm)	Dist. Centros (mm)	Acabado	Bolsa Individual (piezas)	Caja Maestra (piezas)	Exhibidor (No.)
7983	● 110	27	96	Negro	10	100	-
7985	110	27	96	Níquel Satinado	10	100	-
7987	● 144	24	128	Negro	10	100	-
7989	144	24	128	Níquel Satinado	10	100	-

JALADERA ARCO



● **NUEVO ARTÍCULO**

Código	Longitud (mm)	Altura (mm)	Dist. Centros (mm)	Acabado	Bolsa Individual (piezas)	Caja Maestra (piezas)	Exhibidor (No.)
9003*	● 110	27	96	Níquelado	25	100	-
9005*	● 144	24	128	Níquelado	25	100	-

* Sin tornillos

JALADERA DUBLÍN



● **NUEVO ARTÍCULO**

Código	Longitud (mm)	Altura (mm)	Dist. Centros (mm)	Acabado	Bolsa Individual (piezas)	Caja Maestra (piezas)	Exhibidor (No.)
3919	193	25	160	Níquel Satinado	10	100	-
4242	● 193	25	160	Negro	10	100	-
3920	150	25	128	Níquel Satinado	10	100	-
4243	● 150	25	128	Negro	10	100	-



JALADERA LONDRES

● NUEVO ARTÍCULO

Código	Longitud (mm)	Altura (mm)	Dist. Centros (mm)	Acabado	Bolsa Individual (piezas)	Caja Maestra (piezas)	Exhibidor (No.)
3856	168	28	160	Níquel Satinado	10	100	-
4240	● 168	28	160	Negro	10	100	-



3856

4240

JALADERA MÓNACO

● NUEVO ARTÍCULO

Código	Longitud (mm)	Altura (mm)	Dist. Centros (mm)	Acabado	Bolsa Individual (piezas)	Caja Maestra (piezas)	Exhibidor (No.)
3921	225	24	192	Níquel Satinado	10	100	-
4241	● 225	24	192	Negro	10	100	-



3921

4241

JALADERA PORTO

● NUEVO ARTÍCULO

Código	Longitud (mm)	Altura (mm)	Dist. Centros (mm)	Acabado	Bolsa Individual (piezas)	Caja Maestra (piezas)	Exhibidor (No.)
3924	179	22	128	Níquel Satinado	10	100	-
4244	● 179	22	128	Negro	10	100	-



3924

4244

JALADERA ATENAS

● NUEVO ARTÍCULO

Código	Longitud (mm)	Altura (mm)	Dist. Centros (mm)	Acabado	Bolsa Individual (piezas)	Caja Maestra (piezas)	Exhibidor (No.)
3898	136	26	128	Níquel Satinado	10	100	-
4245	● 136	26	128	Negro	10	100	-



3898

4245

JALADERA LISBOA

● NUEVO ARTÍCULO

Código	Longitud (mm)	Altura (mm)	Dist. Centros (mm)	Acabado	Bolsa Individual (piezas)	Caja Maestra (piezas)	Exhibidor (No.)
4252	● 192.5	27.6	160	Níquel Satinado	10	100	-
4253	● 192.5	27.6	160	Negro	10	100	-



4252

4253

JALADERA TURÍN

● NUEVO ARTÍCULO

Código	Longitud (mm)	Altura (mm)	Dist. Centros (mm)	Acabado	Bolsa Individual (piezas)	Caja Maestra (piezas)	Exhibidor (No.)
4274	● 140	28	128	Níquel Satinado	10	100	-
4272	● 140	28	128	Níquel Brillante	10	100	-
4273	● 140	28	128	Negro	10	100	-



4274

4272

4273

BOTÓN GANTE



3935



4246

● **NUEVO ARTÍCULO**

Código	Diámetro (mm)	Altura (mm)	Acabado	Bolsa Individual (piezas)	Caja Maestra (piezas)	Exhibidor (No.)
3935	26.7	19.6	Níquel Satinado	10	100	-
4246	● 26.7	19.6	Negro	10	100	-

BOTÓN BILBAO



4249



4248

● **NUEVO ARTÍCULO**

Código	Diámetro (mm)	Altura (mm)	Acabado	Bolsa Individual (piezas)	Caja Maestra (piezas)	Exhibidor (No.)
4249	● 32.5	34	Níquel Satinado	10	100	-
4248	● 32.5	34	Negro	10	100	-

BOTÓN MÚNICH



4270



4271

● **NUEVO ARTÍCULO**

Código	Diámetro (mm)	Altura (mm)	Acabado	Bolsa Individual (piezas)	Caja Maestra (piezas)	Exhibidor (No.)
4270	● 29.8	24	Níquel Satinado	10	100	-
4271	● 29.8	24	Negro	10	100	-

BOTÓN PRAGA



4258



4259

● **NUEVO ARTÍCULO**

Código	Diámetro (mm)	Altura (mm)	Acabado	Bolsa Individual (piezas)	Caja Maestra (piezas)	Exhibidor (No.)
4258	● 29.5	27.5	Níquel Satinado	10	100	-
4259	● 29.5	27.5	Negro	10	100	-

BOTÓN OXFORD



4256



4257



4255

● **NUEVO ARTÍCULO**

Código	Diámetro (mm)	Altura (mm)	Acabado	Bolsa Individual (piezas)	Caja Maestra (piezas)	Exhibidor (No.)
4256	● 34	26	Níquel Satinado	10	100	-
4257	● 34	26	Níquel Brillante	10	100	-
4255	● 34	26	Negro	10	100	-

PERFILES GOLA

PERFIL GOLA



ALUMINIO

● NUEVO ARTÍCULO

Código	Diseño	Longitud (metros)	Altura (mm)	Material	Acabado	Cantidad por atado (piezas)	Exhibidor (No.)
4286	● "C"	3	745	Aluminio	Negro	10	12
3286	"C"	3	73	Aluminio	-	10	12

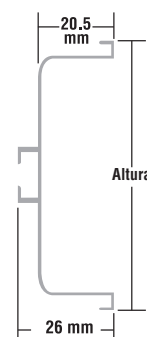

ALUMINIO

● NUEVO ARTÍCULO

Código	Diseño	Longitud (metros)	Altura (mm)	Material	Acabado	Cantidad por atado (piezas)	Exhibidor (No.)
4287	● "L"	3	56.9	Aluminio	Negro	10	12
3287	"L"	3	58	Aluminio	-	10	12

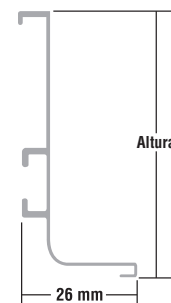

ACCESORIOS PARA PERFIL GOLA

Código	Tipo	Diseño	Material	Acabado	Cantidad por caja (juegos)	Exhibidor (No.)
3743	Soporte Oculto	"Gola"	Acero	Galvanizado	200	12



Código	Tipo	Diseño	Material	Acabado	Cantidad por caja (pares)	Exhibidor (No.)
3741	Tapas	"Gola C"	Plástico	Cromo	200	12
3742	Tapas	"Gola L"	Plástico	Cromo	200	12



ACCESORIOS PARA PERFIL GOLA



● **NUEVO ARTÍCULO**

Código	Tipo	Diseño	Material	Acabado	Cantidad por caja (juegos)	Exhibidor (No.)
4277	● Tapas c/opresor	"Gola L"	Zamac	Negro	200	12
4278	● Tapas c/opresor	"Gola C"	Zamac	Negro	200	12

Código	Tipo	Diseño	Material	Acabado	Cantidad por caja (juegos)	Exhibidor (No.)
3277	Tapas c/opresor	"Gola L"	Zamac	Aluminio	200	12
3278	Tapas c/opresor	"Gola C"	Zamac	Aluminio	200	12



● **NUEVO ARTÍCULO**

Código	Tipo	Diseño	Material	Acabado	Cantidad por caja (piezas)	Exhibidor (No.)
4276	● Esquinero Interno c/opresor	"Gola L"	Zamac	Negro	100	12
4279	● Esquinero Interno c/opresor	"Gola C"	Zamac	Negro	100	12

Código	Tipo	Diseño	Material	Acabado	Cantidad por caja (piezas)	Exhibidor (No.)
3276	Esquinero Interno c/opresor	"Gola L"	Zamac	Aluminio	100	12
3279	Esquinero Interno c/opresor	"Gola C"	Zamac	Aluminio	100	12

PERFIL JALADERA



ALUMINIO

Código	Diseño	Longitud (metros)	Altura (mm)	Espesor Madera (mm)	Material	Cantidad por atado (piezas)	Exhibidor (No.)
3946	"Uno"	3	36	16	Aluminio	10	8



ALUMINIO

Código	Diseño	Longitud (metros)	Altura (mm)	Espesor Madera (mm)	Material	Cantidad por atado (piezas)	Exhibidor (No.)
3947	"Cot"	3	36	16	Aluminio	10	8
3949	"Cot"	3	36	19	Aluminio	10	8



ALUMINIO

Código	Diseño	Longitud (metros)	Altura (mm)	Espesor Madera (mm)	Material	Cantidad por atado (piezas)	Exhibidor (No.)
3948	"Sim"	3	2	16 y 19	Aluminio	10	8



PERFIL JALADERA

A L U M I N I O

Código	Diseño	Longitud (metros)	Altura (mm)	Espesor Madera (mm)	Material	Cantidad por atado (piezas)	Exhibidor (No.)
3945	"Jet"	3	36	16	Aluminio	10	8

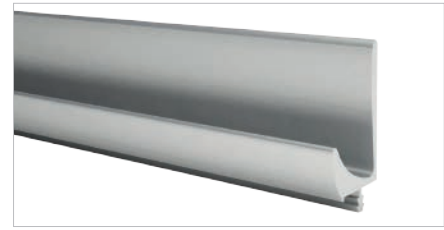

A L U M I N I O

Código	Diseño	Longitud (metros)	Altura (mm)	Espesor Madera (mm)	Material	Cantidad por atado (piezas)	Exhibidor (No.)
3288	"J"	3	37	16	Aluminio	10	13



A L U M I N I O

Código	Diseño	Longitud (metros)	Altura (mm)	Espesor Madera (mm)	Material	Cantidad por atado (piezas)	Exhibidor (No.)
3289	"L"	3	43	25	Aluminio	10	13



A L U M I N I O

● **NUEVO ARTÍCULO**

Código	Diseño	Longitud (metros)	Altura (mm)	Espesor Madera (mm)	Material	Acabado	Cantidad por atado (piezas)	Exhibidor (No.)
4280	● "Cot"	3	37	16	Aluminio	Negro	10	13

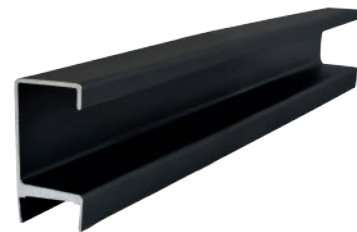

A L U M I N I O

Código	Diseño	Longitud (metros)	Altura (mm)	Espesor Madera (mm)	Material	Cantidad por atado (piezas)	Exhibidor (No.)	
3290	"Cot"	3	37	16	Aluminio		10	13



A L U M I N I O

● **NUEVO ARTÍCULO**

Código	Diseño	Longitud (metros)	Altura (mm)	Espesor Madera (mm)	Material	Acabado	Cantidad por atado (piezas)	Exhibidor (No.)
4281	● "Jet"	3	36.8	16	Aluminio	Negro	10	13



A L U M I N I O

Código	Diseño	Longitud (metros)	Altura (mm)	Espesor Madera (mm)	Material	Cantidad por atado (piezas)	Exhibidor (No.)	
3291	"Jet"	3	36.8	16	Aluminio		10	13





JALADERAS DE BARRA

JALADERAS DE BARRA HUECAS CUADRADAS



79918



79908



79998



79988



Código	Longitud (mm)	Altura (mm)	Dist. Centros (mm)	Material	Acabado	Caja Individual (piezas)	Caja Maestra (piezas)	Exhibidor (No.)
79998	124	35	64	Acero Inoxidable	Negro	25	200	14
79908	156	35	96	Acero Inoxidable	Negro	25	200	14
79918	188	35	128	Acero Inoxidable	Negro	25	200	14
79988	50	35		Acero Inoxidable	Negro	50	400	14

79966



79956



79946



79936



79976



79926



79916



Código	Longitud (mm)	Altura (mm)	Dist. Centros (mm)	Material	Caja Individual (piezas)	Caja Maestra (piezas)	Exhibidor (No.)
79996	124	35	64	Acero Inoxidable	25	200	11
79906	156	35	96	Acero Inoxidable	25	200	11
79916	188	35	128	Acero Inoxidable	25	200	11
79926	220	35	160	Acero Inoxidable	25	200	11
79976	252	35	192	Acero Inoxidable	25	200	11
79936	336	35	256	Acero Inoxidable	25	100	11
79946	400	35	320	Acero Inoxidable	25	100	11
79956	496	35	416	Acero Inoxidable	25	100	11
79966	592	35	512	Acero Inoxidable	25	100	11
79986	50	35		Acero Inoxidable	50	400	11

JALADERAS DE BARRA HUECAS

Código	Longitud (mm)	Altura (mm)	Dist. Centros (mm)	Material	Acabado	Caja Individual (piezas)	Caja Maestra (piezas)	Exhibidor (No.)
79997	124	38	64	Acero Inoxidable	Negro	30	150	14
79907	156	38	96	Acero Inoxidable	Negro	20	100	14
79917	188	38	128	Acero Inoxidable	Negro	20	100	14
79987	40	38		Acero Inoxidable	Negro	20	100	14

ACERO INOXIDABLE



79917

79907

79997



79987

Código	Longitud (mm)	Altura (mm)	Dist. Centros (mm)	Material	Caja Individual (piezas)	Caja Maestra (piezas)	Exhibidor (No.)
79995	124	38	64	Acero Inoxidable	40	400	1
79905	156	38	96	Acero Inoxidable	40	400	1
79915	188	38	128	Acero Inoxidable	40	400	1
79925	220	38	160	Acero Inoxidable	40	400	1
79975	252	38	192	Acero Inoxidable	20	200	1
79935	336	38	256	Acero Inoxidable	20	200	1
79945	400	38	320	Acero Inoxidable	20	200	1
79955	496	38	416	Acero Inoxidable	20	200	1
79965	592	38	512	Acero Inoxidable	20	200	1
79985	40	38		Acero Inoxidable	40	400	1

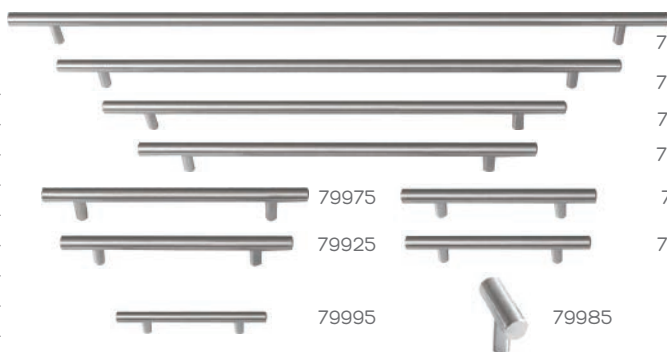

79965

79955

79945

79935

79915

79905

79975

79925

79995

79985

JALADERAS DE BARRA

Código	Longitud (mm)	Altura (mm)	Dist. Centros (mm)	Acabado	Caja Individual (piezas)	Caja Maestra (piezas)	Exhibidor (No.)
7999	124	38	64	Níquel Satinado	25	150	1
7981	135	38	76.2	Níquel Satinado	20	100	1
7990	156	38	96	Níquel Satinado	20	100	1
7991	188	38	128	Níquel Satinado	20	100	1
7992	220	38	160	Níquel Satinado	50	100	1
7997	252	38	192	Níquel Satinado	10	60	1
7993	336	38	256	Níquel Satinado	10	60	1
7994	400	38	320	Níquel Satinado	10	60	1
7995	496	38	416	Níquel Satinado	10	40	1
7996	592	38	512	Níquel Satinado	10	40	1
7998	40	38		Níquel Satinado	40	320	1

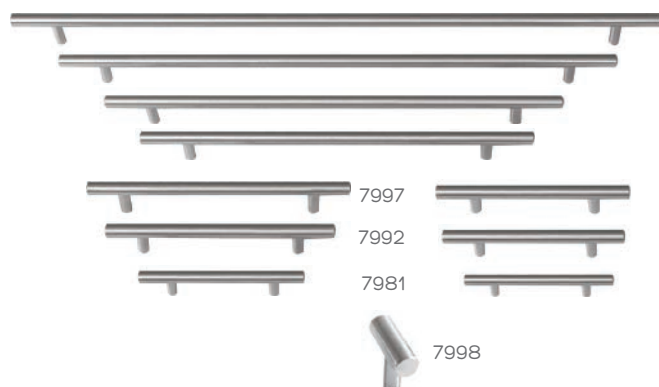

7996

7995

7994

7993

7991

7990

7999

7997

7992

7981

7998

Código	Longitud (mm)	Altura (mm)	Dist. Centros (mm)	Material	Caja Individual (piezas)	Caja Maestra (piezas)	Exhibidor (No.)
7101	188	35	155	A. Inox / B. N.S	25	200	4
7102	223	35	190	A. Inox / B. N.S	25	200	4
7103	253	35	220	A. Inox / B. N.S	25	200	4
7104	283	35	250	A. Inox / B. N.S	25	200	4
7105	353	35	320	A. Inox / B. N.S	20	200	4
7106	443	35	410	A. Inox / B. N.S	20	200	4
7107	483	35	450	A. Inox / B. N.S	20	200	4



7107

7106

7105

7102

7101

7104

7103

Código	Longitud (mm)	Altura (mm)	Dist. Centros (mm)	Material	Caja Individual (piezas)	Caja Maestra (piezas)	Exhibidor (No.)
3858	156	36	128	Níquel Satinado	20	100	4
3859	220	36	190	Níquel Satinado	16	100	4
3860	380	36	350	Níquel Satinado	10	60	4
3861	430	36	402	Níquel Satinado	15	60	4



3861

3860

3859

3858



JALADERAS CONTEMPORÁNEAS

JALADERAS CONTEMPORÁNEAS

3781



Código	Longitud (mm)	Altura (mm)	Dist. Centros (mm)	Acabado	Caja Individual (piezas)	Caja Maestra (piezas)	Exhibidor (No.)
3781	178	33	160	Cromo	30	150	9

3788



Código	Longitud (mm)	Altura (mm)	Dist. Centros (mm)	Acabado	Caja Individual (piezas)	Caja Maestra (piezas)	Exhibidor (No.)
3788	140	22	128	Níquel Satinado	25	250	9

3789



Código	Longitud (mm)	Altura (mm)	Dist. Centros (mm)	Acabado	Caja Individual (piezas)	Caja Maestra (piezas)	Exhibidor (No.)
3789	146	26	128	Níquel Satinado	20	200	9

3793



Código	Longitud (mm)	Altura (mm)	Dist. Centros (mm)	Acabado	Caja Individual (piezas)	Caja Maestra (piezas)	Exhibidor (No.)
3793	185	25	160	Níquel Satinado	40	160	9

JALADERAS CONTEMPORÁNEAS

Código	Longitud (mm)	Altura (mm)	Dist. Centros (mm)	Acabado	Caja Individual (piezas)	Caja Maestra (piezas)	Exhibidor (No.)
3794	180	26	160	Níquel Satinado	16	160	9



3794

Código	Longitud (mm)	Altura (mm)	Dist. Centros (mm)	Acabado	Caja Individual (piezas)	Caja Maestra (piezas)	Exhibidor (No.)
3795	168	24	160	Níquel Satinado	20	200	9



3795

Código	Longitud (mm)	Altura (mm)	Dist. Centros (mm)	Acabado	Caja Individual (piezas)	Caja Maestra (piezas)	Exhibidor (No.)
3796	90	24	60	Níquel Satinado	20	200	9
3797	160	24	130	Níquel Satinado	20	200	9
3798	260	24	200	Níquel Satinado	20	100	9

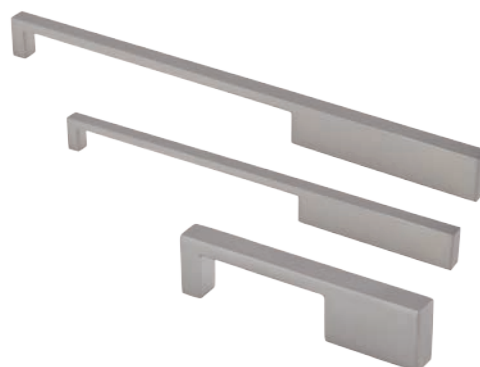

3798

3797

3796

Código	Longitud (mm)	Altura (mm)	Dist. Centros (mm)	Acabado	Caja Individual (piezas)	Caja Maestra (piezas)	Exhibidor (No.)
3799	135	28	96	Níquel Satinado	50	300	9



3799

Código	Longitud (mm)	Altura (mm)	Dist. Centros (mm)	Acabado	Caja Individual (piezas)	Caja Maestra (piezas)	Exhibidor (No.)
3974	174	36	160	Níquel Satinado	10	150	9



3974

Código	Longitud (mm)	Altura (mm)	Dist. Centros (mm)	Acabado	Caja Individual (piezas)	Caja Maestra (piezas)	Exhibidor (No.)
3975	157	29	128	Níquel Satinado	25	100	9



3975

JALADERAS CONTEMPORÁNEAS

3976



Código	Longitud (mm)	Altura (mm)	Dist. Centros (mm)	Acabado	Caja Individual (piezas)	Caja Maestra (piezas)	Exhibidor (No.)
3976	201	25	160	Níquel Satinado	40	160	9

3977



Código	Longitud (mm)	Altura (mm)	Dist. Centros (mm)	Acabado	Caja Individual (piezas)	Caja Maestra (piezas)	Exhibidor (No.)
3977	150	31	128	Níquel Satinado	20	200	9

3978



Código	Longitud (mm)	Altura (mm)	Dist. Centros (mm)	Acabado	Caja Individual (piezas)	Caja Maestra (piezas)	Exhibidor (No.)
3978	201	25	160	Níquel Satinado	40	160	9

3979



Código	Longitud (mm)	Altura (mm)	Dist. Centros (mm)	Acabado	Caja Individual (piezas)	Caja Maestra (piezas)	Exhibidor (No.)
3979	196	30	128	Níquel Satinado	40	200	9

3982



Código	Longitud (mm)	Altura (mm)	Dist. Centros (mm)	Acabado	Caja Individual (piezas)	Caja Maestra (piezas)	Exhibidor (No.)
3982	260	24	200	Cromo	10	100	9

3983



Código	Longitud (mm)	Altura (mm)	Dist. Centros (mm)	Acabado	Caja Individual (piezas)	Caja Maestra (piezas)	Exhibidor (No.)
3983	192	28	128	Níquel Satinado	40	160	9

3928



ALUMINIO

Código	Longitud (mm)	Altura (mm)	Dist. Centros (mm)	Material	Caja Individual (piezas)	Caja Maestra (piezas)	Exhibidor (No.)
3928	167	30	160	Aluminio	20	120	6

JALADERAS CONTEMPORÁNEAS

A L U M I N I O

Código	Longitud (mm)	Altura (mm)	Dist. Centros (mm)	Material	Caja Individual (piezas)	Caja Maestra (piezas)	Exhibidor (No.)
3784	206	27	160	Aluminio	15	150	9



3784

A L U M I N I O

Código	Longitud (mm)	Altura (mm)	Dist. Centros (mm)	Acabado	Caja Individual (piezas)	Caja Maestra (piezas)	Exhibidor (No.)
3785	206	27	160	Cromo	15	150	9



3785

A L U M I N I O

Código	Longitud (mm)	Altura (mm)	Dist. Centros (mm)	Acabado	Caja Individual (piezas)	Caja Maestra (piezas)	Exhibidor (No.)
3786	180	27	160	Cromo	45	180	9



3786

A L U M I N I O

Código	Longitud (mm)	Altura (mm)	Dist. Centros (mm)	Material	Caja Individual (piezas)	Caja Maestra (piezas)	Exhibidor (No.)
3787	180	27	160	Aluminio	45	180	9



3787

A L U M I N I O

Código	Longitud (mm)	Altura (mm)	Dist. Centros (mm)	Acabado	Caja Individual (piezas)	Caja Maestra (piezas)	Exhibidor (No.)
3940	295	29	256	Níquel Satinado	25	150	6



3940

A L U M I N I O

Código	Longitud (mm)	Altura (mm)	Dist. Centros (mm)	Material	Caja Individual (piezas)	Caja Maestra (piezas)	Exhibidor (No.)
3942	110	18	96	Aluminio	50	500	6

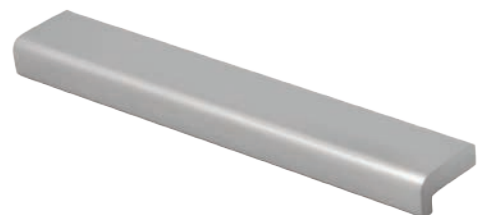

3942

A L U M I N I O

Código	Longitud (mm)	Altura (mm)	Dist. Centros (mm)	Material	Caja Individual (piezas)	Caja Maestra (piezas)	Exhibidor (No.)
3943	115	17	96	Aluminio	50	500	6



3943

JALADERAS CONTEMPORÁNEAS

3911



ALUMINIO

3912

3913

3914

Código	Longitud (mm)	Altura (mm)	Dist. Centros (mm)	Material	Caja Individual (piezas)	Caja Maestra (piezas)	Exhibidor (No.)
3911	297	18	288	Aluminio	25	500	6
3912	233	18	224	Aluminio	25	200	6
3913	170	18	160	Aluminio	25	200	6
3914	139	18	128	Aluminio	30	400	6

3910

3906



ALUMINIO

Código	Longitud (mm)	Altura (mm)	Dist. Centros (mm)	Material	Caja Individual (piezas)	Caja Maestra (piezas)	Exhibidor (No.)
3910	177	25	160	Aluminio	30	400	6
3906	146	23	128	Aluminio	30	300	6

3922

3917



Código	Longitud (mm)	Altura (mm)	Dist. Centros (mm)	Acabado	Caja Individual (piezas)	Caja Maestra (piezas)	Exhibidor (No.)
3922	170	28	160	Níquel Satinado	15	150	6
3917	138	28	128	Níquel Satinado	30	500	6

3908

3907



Código	Longitud (mm)	Altura (mm)	Dist. Centros (mm)	Acabado	Caja Individual (piezas)	Caja Maestra (piezas)	Exhibidor (No.)
3908	172	24	157	Níquel Satinado	20	200	6
3907	142	24	128	Níquel Satinado	30	200	6

3930



Código	Longitud (mm)	Altura (mm)	Dist. Centros (mm)	Acabado	Caja Individual (piezas)	Caja Maestra (piezas)	Exhibidor (No.)
3930	143	21	128	Níquel Satinado	35	500	6

3931



Código	Longitud (mm)	Altura (mm)	Dist. Centros (mm)	Acabado	Caja Individual (piezas)	Caja Maestra (piezas)	Exhibidor (No.)
3931	155	22	128	Níquel Satinado	25	250	6

JALADERAS CONTEMPORÁNEAS

Código	Longitud (mm)	Altura (mm)	Dist. Centros (mm)	Acabado	Caja Individual (piezas)	Caja Maestra (piezas)	Exhibidor (No.)
3925	131	28	96	Níquel Satinado	25	150	6



3925

Código	Longitud (mm)	Altura (mm)	Dist. Centros (mm)	Acabado	Caja Individual (piezas)	Caja Maestra (piezas)	Exhibidor (No.)
3944	167	35	160	Níquel Satinado	25	150	6
3933	135	35	128	Níquel Satinado	50	500	6



3944

3933

Código	Longitud (mm)	Altura (mm)	Dist. Centros (mm)	Acabado	Caja Individual (piezas)	Caja Maestra (piezas)	Exhibidor (No.)
3857	137	26	128	Níquel Satinado	30	300	4



3857

Código	Longitud (mm)	Altura (mm)	Dist. Centros (mm)	Acabado	Caja Individual (piezas)	Caja Maestra (piezas)	Exhibidor (No.)
3877	139	33	128	Níquel Satinado	30	300	2
3884	107	28	96	Níquel Satinado	30	400	2



3877

3884

Código	Longitud (mm)	Altura (mm)	Dist. Centros (mm)	Acabado	Caja Individual (piezas)	Caja Maestra (piezas)	Exhibidor (No.)
3878	152	30	128	Níquel Satinado	30	300	2



3878

Código	Longitud (mm)	Altura (mm)	Dist. Centros (mm)	Acabado	Caja Individual (piezas)	Caja Maestra (piezas)	Exhibidor (No.)
3867	100	20	76	Níquel Satinado	50	500	2



3867

JALADERAS CONTEMPORÁNEAS

3879



Código	Longitud (mm)	Altura (mm)	Dist. Centros (mm)	Acabado	Caja Individual (piezas)	Caja Maestra (piezas)	Exhibidor (No.)
3879	137	28	96	Níquel Satinado	24	300	2

3874



Código	Longitud (mm)	Altura (mm)	Dist. Centros (mm)	Acabado	Caja Individual (piezas)	Caja Maestra (piezas)	Exhibidor (No.)
3874	141	24	128	Níquel Satinado	40	400	2

3882



Código	Longitud (mm)	Altura (mm)	Dist. Centros (mm)	Acabado	Caja Individual (piezas)	Caja Maestra (piezas)	Exhibidor (No.)
3882	110	26	96	Níquel Satinado	50	500	2

3865



Código	Longitud (mm)	Altura (mm)	Dist. Centros (mm)	Acabado	Caja Individual (piezas)	Caja Maestra (piezas)	Exhibidor (No.)
3865	112	28	96	Níquel Satinado	80	500	2

3923



3916

Código	Longitud (mm)	Altura (mm)	Dist. Centros (mm)	Acabado	Caja Individual (piezas)	Caja Maestra (piezas)	Exhibidor (No.)
3923	213	24	160	Níquel Satinado	25	150	6
3916	145	23	96	Níquel Satinado	30	400	6

JALADERAS CONTEMPORÁNEAS

Código	Longitud (mm)	Altura (mm)	Dist. Centros (mm)	Acabado	Caja Individual (piezas)	Caja Maestra (piezas)	Exhibidor (No.)
3918	223	25	192	Níquel Satinado	20	100	6



3918

Código	Longitud (mm)	Altura (mm)	Dist. Centros (mm)	Acabado	Caja Individual (piezas)	Caja Maestra (piezas)	Exhibidor (No.)
3926	153	24	128	Níquel Satinado	30	120	6



3926

Código	Longitud (mm)	Altura (mm)	Dist. Centros (mm)	Acabado	Caja Individual (piezas)	Caja Maestra (piezas)	Exhibidor (No.)
3927	157	20	128	Níquel Satinado	40	120	6



3927

Código	Longitud (mm)	Altura (mm)	Dist. Centros (mm)	Acabado	Caja Individual (piezas)	Caja Maestra (piezas)	Exhibidor (No.)
3883	87	23	32	Níquel Satinado	40	500	2



3883

Código	Longitud (mm)	Altura (mm)	Dist. Centros (mm)	Acabado	Caja Individual (piezas)	Caja Maestra (piezas)	Exhibidor (No.)
3880	128	30	96	Zamac	30	300	2



3880

JALADERAS CONTEMPORÁNEAS



Código	Longitud (mm)	Altura (mm)	Dist. Centros (mm)	Acabado	Caja Individual (piezas)	Caja Maestra (piezas)	Exhibidor (No.)
3873	127	27	96	Cromo Mate	50	500	2
3876	127	27	96	Níquel Satinado	50	500	2



Código	Longitud (mm)	Altura (mm)	Dist. Centros (mm)	Acabado	Caja Individual (piezas)	Caja Maestra (piezas)	Exhibidor (No.)
3805	116	30	96	Níquel Satinado	50	500	2
3804	116	30	96	Latón Brillante	50	500	2



Código	Longitud (mm)	Altura (mm)	Dist. Centros (mm)	Acabado	Caja Individual (piezas)	Caja Maestra (piezas)	Exhibidor (No.)
3809	123	25	96	Níquel Satinado	40	500	2
4049	129	25	96	Níquel Satinado	40	500	2
3808	123	25	96	Latón Brillante	40	500	2
4048	129	25	96	Latón Brillante	40	500	2

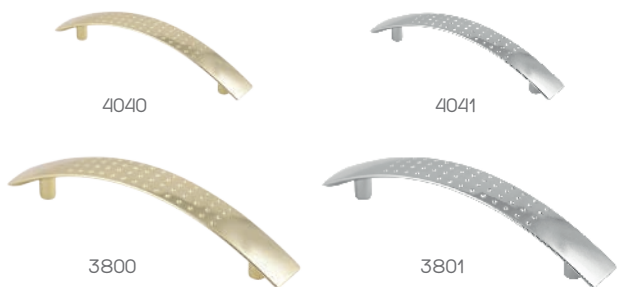

Código	Longitud (mm)	Altura (mm)	Dist. Centros (mm)	Acabado	Caja Individual (piezas)	Caja Maestra (piezas)	Exhibidor (No.)
3801	142	29	96	Níquel Satinado	20	200	2
4041	124	29	96	Níquel Satinado	20	200	2
3800	142	29	96	Latón Brillante	20	400	2
4040	124	29	96	Latón Brillante	20	400	2



Código	Longitud (mm)	Altura (mm)	Dist. Centros (mm)	Acabado	Caja Individual (piezas)	Caja Maestra (piezas)	Exhibidor (No.)
3864	111	21	96	Cromo Satinado	40	500	2
3870	111	21	96	Níquel Satinado	50	500	2

JALADERAS CONTEMPORÁNEAS

Código	Longitud (mm)	Altura (mm)	Dist. Centros (mm)	Acabado	Caja Individual (piezas)	Caja Maestra (piezas)	Exhibidor (No.)
3807	108	35	96	Níquel Satinado	50	500	2
3806	108	35	96	Latón Brillante	50	500	2



3806



3807

Código	Longitud (mm)	Altura (mm)	Dist. Centros (mm)	Acabado	Caja Individual (piezas)	Caja Maestra (piezas)	Exhibidor (No.)
7984	110	27	96	Latón Brillante	50	1000	2
7986	110	27	96	Cromo	50	1000	2
7988	145	24	128	Latón Brillante	50	500	2
7982	145	24	128	Cromo	40	500	2



7982

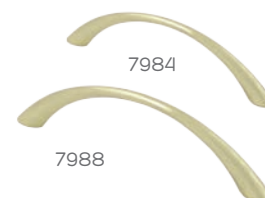

7984

7988

Código	Longitud (mm)	Altura (mm)	Dist. Centros (mm)	Acabado	Caja Individual (piezas)	Caja Maestra (piezas)	Exhibidor (No.)
3872	110	30	96	Níquel Negro	40	500	2
3875	112	31	96	Níquel Satinado	25	500	2



3872



3875

Código	Longitud (mm)	Altura (mm)	Dist. Centros (mm)	Acabado	Caja Individual (piezas)	Caja Maestra (piezas)	Exhibidor (No.)
3901	140	31	128	Níquel Satinado	30	250	4
3900	108	31	96	Níquel Satinado	50	250	4



3900

3901

Código	Longitud (mm)	Altura (mm)	Dist. Centros (mm)	Acabado	Caja Individual (piezas)	Caja Maestra (piezas)	Exhibidor (No.)
3903	140	32	128	Níquel Satinado	25	120	4
3902	107	32	96	Níquel Satinado	50	300	4



3902

3903

Código	Longitud (mm)	Altura (mm)	Dist. Centros (mm)	Acabado	Caja Individual (piezas)	Caja Maestra (piezas)	Exhibidor (No.)
3899	167	27	160	Níquel Satinado	25	300	4



3899

JALADERAS DE EMBUTIR

ALUMINIO



3565

3566

3567

Código	Longitud (mm)	Altura (mm)	Dist. Centros (mm)	Material	Caja Individual (piezas)	Caja Maestra (piezas)	Exhibidor (No.)
3565	81x42	15	64	Aluminio	35	350	3
3566	112x42	15	96	Aluminio	30	300	3
3567	144x42	15	123	Aluminio	25	250	3



3904

3897

3905

Código	Longitud (mm)	Altura (mm)	Dist. Centros (mm)	Acabado	Caja Individual (piezas)	Caja Maestra (piezas)	Exhibidor (No.)
3904	74x41	11	64	Níquel Satinado	30	300	3
3897	107x41	11	96	Níquel Satinado	25	300	3
3905	138x41	11	128	Níquel Satinado	20	300	3

BOTONES CONTEMPORÁNEOS

3984



Código	Longitud (mm)	Altura (mm)	Acabado	Caja Individual (piezas)	Caja Maestra (piezas)	Exhibidor (No.)
3984	59	15	Níquel Satinado	30	300	9

3985



Código	Longitud (mm)	Altura (mm)	Acabado	Caja Individual (piezas)	Caja Maestra (piezas)	Exhibidor (No.)
3985	45	12.5	Níquel Satinado	30	300	9

3986



Código	Longitud (mm)	Altura (mm)	Acabado	Caja Individual (piezas)	Caja Maestra (piezas)	Exhibidor (No.)
3986	57	35	Níquel Satinado	50	200	9

3987



Código	Longitud (mm)	Altura (mm)	Dist. Centros (mm)	Acabado	Caja Individual (piezas)	Caja Maestra (piezas)	Exhibidor (No.)
3987	45	22	32	Níquel Satinado	50	300	9

BOTONES CONTEMPORÁNEOS

Código	Acabado	Caja Individual (piezas)	Caja Maestra (piezas)	Exhibidor (No.)
3988	Níquel Satinado	60	300	9



3988

Código	Longitud (mm)	Altura (mm)	Dist. Centros (mm)	Acabado	Caja Individual (piezas)	Caja Maestra (piezas)	Exhibidor (No.)
3934	50	20	32	Níquel Satinado	40	400	3



3934

Código	Longitud (mm)	Altura (mm)	Dist. Centros (mm)	Acabado	Caja Individual (piezas)	Caja Maestra (piezas)	Exhibidor (No.)
3936	50	22	32	Níquel Satinado	40	300	3



3936

ALUMINIO

Código	Longitud (mm)	Altura (mm)	Dist. Centros (mm)	Material	Caja Individual (piezas)	Caja Maestra (piezas)	Exhibidor (No.)
3937	69	23	32	Aluminio	40	400	3

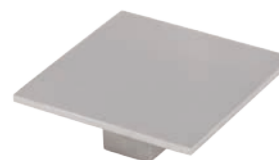

3937

Código	Longitud (mm)	Altura (mm)	Dist. Centros (mm)	Acabado	Caja Individual (piezas)	Caja Maestra (piezas)	Exhibidor (No.)
3915	25	23	15	Níquel Satinado	50	1,000	3



3915

Código	Longitud (mm)	Altura (mm)	Dist. Centros (mm)	Acabado	Caja Individual (piezas)	Caja Maestra (piezas)	Exhibidor (No.)
3938	43	20	19	Níquel Satinado	40	400	3



3938

BOTONES CONTEMPORÁNEOS



Código	Diámetro (mm)	Altura (mm)	Acabado	Caja Individual (piezas)	Caja Maestra (piezas)	Exhibidor (No.)
3939	22	24	Níquel Satinado	50	1000	3



Código	Diámetro (mm)	Altura (mm)	Acabado	Caja Individual (piezas)	Caja Maestra (piezas)	Exhibidor (No.)
3803	32	26	Níquel Satinado	20	300	3
4043	27.8	23.6	Níquel Satinado	20	300	3
3802	28	24	Latón Brillante	20	300	3

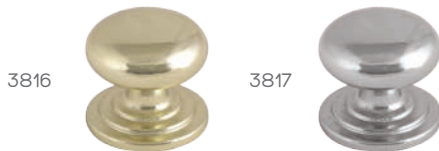

Código	Diámetro (mm)	Altura (mm)	Acabado	Caja Individual (piezas)	Caja Maestra (piezas)	Exhibidor (No.)
3817	30	26	Níquel Satinado	40	500	3
3816	32.3	24.6	Latón Brillante	40	500	3



Código	Diámetro (mm)	Altura (mm)	Acabado	Caja Individual (piezas)	Caja Maestra (piezas)	Exhibidor (No.)
3851	22	26	Níquel Satinado	40	500	3
3850	22	26	Latón Brillante	50	500	3



Código	Diámetro (mm)	Altura (mm)	Acabado	Caja Individual (piezas)	Caja Maestra (piezas)	Exhibidor (No.)
3823	25	22	Níquel Satinado	50	500	3
3822	25	22	Latón Brillante	50	500	3



Código	Diámetro (mm)	Altura (mm)	Acabado	Caja Individual (piezas)	Caja Maestra (piezas)	Exhibidor (No.)
3844	20	22	Níquel Satinado	100	1000	3



Código	Diámetro (mm)	Altura (mm)	Acabado	Caja Individual (piezas)	Caja Maestra (piezas)	Exhibidor (No.)
3892	30	19	Níquel Satinado	40	400	3

BOTONES CONTEMPORÁNEOS

Código	Diámetro (mm)	Altura (mm)	Acabado	Caja Individual (piezas)	Caja Maestra (piezas)	Exhibidor (No.)
3869	30	28	Níquel Satinado	40	500	3



3869

Código	Diámetro (mm)	Altura (mm)	Acabado	Caja Individual (piezas)	Caja Maestra (piezas)	Exhibidor (No.)
3855	31	29	Níquel Satinado	40	500	3
3854	31	29	Latón Brillante	50	500	3



3854



3855

Código	Diámetro (mm)	Altura (mm)	Acabado	Caja Individual (piezas)	Caja Maestra (piezas)	Exhibidor (No.)
3821	21.3	25.7	Níquel Satinado	40	400	3
3820	25	29	Latón Brillante	40	500	3



3820



3821

Código	Diámetro (mm)	Altura (mm)	Acabado	Caja Individual (piezas)	Caja Maestra (piezas)	Exhibidor (No.)
3811	32	28	Níquel Satinado	40	400	3
3810	32	28	Latón Brillante	40	500	3



3810



3811

● **NUEVO ARTÍCULO**

Código	Diámetro (mm)	Altura (mm)	Acabado	Caja Individual (piezas)	Caja Maestra (piezas)	Exhibidor (No.)
3853	29	25	Níquel Satinado	50	500	3
3852	29	25	Latón Brillante	50	1000	3
3989	25	25	Níquel Satinado	100	500	3
3995	● 25	23	Latón Brillante	50	500	3



3852



3853



3989



3995

Código	Diámetro (mm)	Altura (mm)	Acabado	Caja Individual (piezas)	Caja Maestra (piezas)	Exhibidor (No.)
3814	29	21	Latón Brillante	100	1000	3
3815	27	19	Níquel Satinado	100	1000	3



3814



3815

BOTONES CONTEMPORÁNEOS

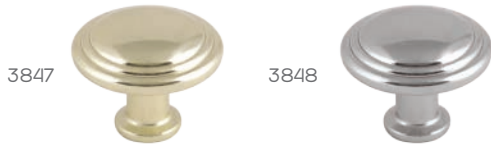

Código	Diámetro (mm)	Altura (mm)	Acabado	Caja Individual (piezas)	Caja Maestra (piezas)	Exhibidor (No.)
3848	29	23	Níquel Satinado	50	1000	3
3847	29	23	Latón Brillante	50	500	3



Código	Diámetro (mm)	Altura (mm)	Acabado	Caja Individual (piezas)	Caja Maestra (piezas)	Exhibidor (No.)
3881	35	36	Níquel Satinado	30	300	3



Código	Diámetro (mm)	Altura (mm)	Acabado	Caja Individual (piezas)	Caja Maestra (piezas)	Exhibidor (No.)
3863	30	27	Latón Antiguo	50	500	3
3868	30	27	Níquel Satinado	50	500	3



Código	Diámetro (mm)	Altura (mm)	Acabado	Caja Individual (piezas)	Caja Maestra (piezas)	Exhibidor (No.)
3819	18	23	Níquel Satinado	50	500	3
3818	18	23	Latón Brillante	50	500	3

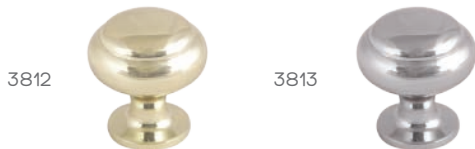

Código	Diámetro (mm)	Altura (mm)	Acabado	Caja Individual (piezas)	Caja Maestra (piezas)	Exhibidor (No.)
3813	23	23	Níquel Satinado	50	500	3
3812	23	23	Latón Brillante	50	500	3

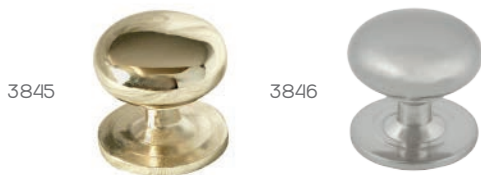

Código	Diámetro (mm)	Altura (mm)	Acabado	Caja Individual (piezas)	Caja Maestra (piezas)	Exhibidor (No.)
3846	23	23	Níquel Satinado	50	500	3
3845	23	23	Latón Brillante	50	500	3



Código	Longitud (mm)	Altura (mm)	Acabado	Caja Individual (piezas)	Caja Maestra (piezas)	Exhibidor (No.)
3896	6	19	Níquel Satinado	100	150	3

JALADERAS TRADICIONALES

TRADICIONALES

Código	Longitud (mm)	Altura (mm)	Dist. Centros (mm)	Acabado	Caja Individual (piezas)	Caja Maestra (piezas)	Exhibidor (No.)
3891	122	23	76	Níquel Satinado	40	250	7



3891

Código	Longitud (mm)	Altura (mm)	Dist. Centros (mm)	Acabado	Caja Individual (piezas)	Caja Maestra (piezas)	Exhibidor (No.)
3866	117	26	76	Níquel Satinado	40	400	7



3866

Código	Longitud (mm)	Altura (mm)	Dist. Centros (mm)	Acabado	Caja Individual (piezas)	Caja Maestra (piezas)	Exhibidor (No.)
3862	121	20	76	Latón Antiguo	40	400	7



3862

Código	Longitud (mm)	Altura (mm)	Dist. Centros (mm)	Acabado	Caja Individual (piezas)	Caja Maestra (piezas)	Exhibidor (No.)
3871	128	22	76	Níquel Satinado	40	400	7
3831	128	26	76	Latón Antiguo	40	500	7
3830	128	26	76	Latón Brillante	40	400	7



3830

3871

3831

JALADERAS TRADICIONALES



Código	Longitud (mm)	Altura (mm)	Dist. Centros (mm)	Acabado	Caja Individual (piezas)	Caja Maestra (piezas)	Exhibidor (No.)
3841	128	23	76	Latón Antiguo	40	500	7
3840	128	23	76	Latón Brillante	50	500	7



Código	Longitud (mm)	Altura (mm)	Dist. Centros (mm)	Acabado	Caja Individual (piezas)	Caja Maestra (piezas)	Exhibidor (No.)
3842	140	15	76	Latón Brillante	40	500	7
3843	140	19	76	Latón Antiguo	50	500	7



Código	Longitud (mm)	Altura (mm)	Dist. Centros (mm)	Acabado	Caja Individual (piezas)	Caja Maestra (piezas)	Exhibidor (No.)
3828	129	22	76	Latón Brillante	50	500	7
3829	129	22	76	Latón Antiguo	40	500	7
3893	129	22	76	Níquel Satinado	50	250	7



Código	Longitud (mm)	Altura (mm)	Dist. Centros (mm)	Acabado	Caja Individual (piezas)	Caja Maestra (piezas)	Exhibidor (No.)
3889	141	19	76	Latón Antiguo	40	200	7
3886	144	21	76	Latón Antiguo	50	200	7



Código	Longitud (mm)	Altura (mm)	Dist. Centros (mm)	Acabado	Caja Individual (piezas)	Caja Maestra (piezas)	Exhibidor (No.)
3888	141	26	76	Latón Antiguo	40	250	7

JALADERAS TRADICIONALES

Código	Longitud (mm)	Altura (mm)	Dist. Centros (mm)	Acabado	Caja Individual (piezas)	Caja Maestra (piezas)	Exhibidor (No.)
3885	139	21	76	Latón Antiguo	40	250	7



3885

Código	Longitud (mm)	Altura (mm)	Dist. Centros (mm)	Acabado	Caja Individual (piezas)	Caja Maestra (piezas)	Exhibidor (No.)
4227	128	31	75	Latón Antiguo	40	500	7
4229	128	31	75	Latón Brillante	40	400	7
4237	128	31	75	Latón Brillante	30	500	7
4247	128	31	75	Latón Brillante	40	500	7



4227



4229



4237



4247

BOTONES TRADICIONALES

Código	Diámetro (mm)	Altura (mm)	Acabado	Caja Individual (piezas)	Caja Maestra (piezas)	Exhibidor (No.)
4228	32	24	Latón Antiguo	40	500	7
4231	32	24	Latón Brillante	40	500	7
4239	32	24	Latón Brillante	40	500	7
4251	32	24	Latón Brillante	50	500	7

4231



4251



4239



4228



Código	Diámetro (mm)	Altura (mm)	Acabado	Caja Individual (piezas)	Caja Maestra (piezas)	Exhibidor (No.)
3839	28	20	Latón Antiguo	40	1,000	7
3838	28	20	Latón Brillante	50	500	7

3838



3839



Código	Diámetro (mm)	Altura (mm)	Acabado	Caja Individual (piezas)	Caja Maestra (piezas)	Exhibidor (No.)
3837	31	21	Latón Antiguo	50	1,000	7
3836	31	21	Latón Brillante	100	1,000	7

3836



3837



BOTONES TRADICIONALES



Código	Diámetro (mm)	Altura (mm)	Acabado	Caja Individual (piezas)	Caja Maestra (piezas)	Exhibidor (No.)
3826	34	24	Latón Brillante	100	1,000	7
3827	30	23	Latón Brillante	40	1,000	7



Código	Diámetro (mm)	Altura (mm)	Acabado	Caja Individual (piezas)	Caja Maestra (piezas)	Exhibidor (No.)
3835	28	22	Níquel Satinado	50	500	7
3834	28	22	Latón Brillante	50	500	7
3980	28	22	Latón Antiguo	50	500	7



Código	Diámetro (mm)	Altura (mm)	Acabado	Caja Individual (piezas)	Caja Maestra (piezas)	Exhibidor (No.)
3824	34	21	Latón Brillante	40	400	7
3825	30	21	Latón Brillante	100	1,000	7



Código	Longitud (mm)	Altura (mm)	Acabado	Caja Individual (piezas)	Caja Maestra (piezas)	Exhibidor (No.)
3833	66	23	Latón Antiguo	40	400	7
3832	66	23	Latón Brillante	40	400	7



Código	Diámetro (mm)	Altura (mm)	Acabado	Caja Individual (piezas)	Caja Maestra (piezas)	Exhibidor (No.)
3894	33	28	Níquel Satinado	50	200	7



Código	Diámetro (mm)	Altura (mm)	Acabado	Caja Individual (piezas)	Caja Maestra (piezas)	Exhibidor (No.)
3895	24	27	Níquel Satinado	50	250	7

BOTONES TRADICIONALES

Código	Diámetro (mm)	Altura (mm)	Acabado	Caja Individual (piezas)	Caja Maestra (piezas)	Exhibidor (No.)
3890	35	16	Latón Antiguo	40	200	7



3890

Código	Diámetro (mm)	Altura (mm)	Acabado	Caja Individual (piezas)	Caja Maestra (piezas)	Exhibidor (No.)
3887	36	21	Latón Antiguo	40	1,000	7



3887

Código	Diámetro (mm)	Altura (mm)	Acabado	Caja Individual (piezas)	Caja Maestra (piezas)	Exhibidor (No.)
3849	33	18	Latón Brillante	100	1,000	7



3849

TRADICIONALES DE EMBUTIR

Código	Longitud (mm)	Altura (mm)	Acabado	Caja Individual (piezas)	Caja Maestra (piezas)	Exhibidor (No.)
4260	85 x 35	12	Latón Brillante	40	400	7



4260

Código	Longitud (mm)	Altura (mm)	Acabado	Caja Individual (piezas)	Caja Maestra (piezas)	Exhibidor (No.)
4261	85 x 35	9	Latón Brillante	50	500	7



4261

Código	Longitud (mm)	Altura (mm)	Acabado	Caja Individual (piezas)	Caja Maestra (piezas)	Exhibidor (No.)
4269	90 x 26	10	Latón Brillante	40	400	7

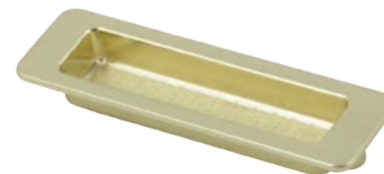

4269

TORNILLOS PARA JALADERAS

Código	Longitud (mm)	Longitud (Pulgadas)	Acabado	Presentación (Millares x caja)
3219	5/32"	3/8"	Galvanizado	15
3214	M4	3/4"	Galvanizado	10
3217	M4	1 3/8"	Galvanizado	7
3210	M4	7/8"	Galvanizado	10
3211	M4	1 1/4"	Galvanizado	7
3212	M4	1 1/2"	Galvanizado	1
3213	M4	1 3/4" (Recortable)	Galvanizado	1





APOYO A MERCADOTECNIA



7861
Exhibidor #8



7862
Exhibidor #9



7842
Exhibidor #2

APOYO A MERCADOTECNIA

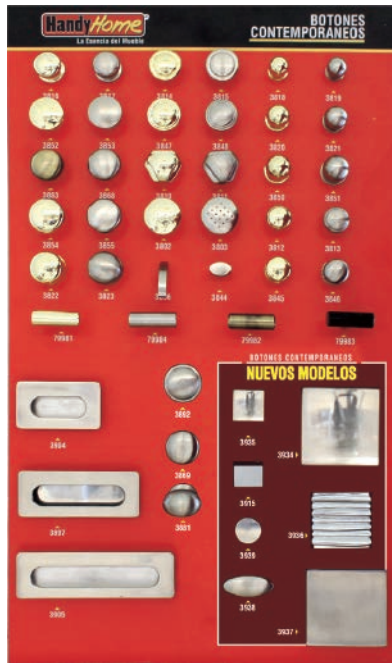

7843
Exhibidor #3



7841
Exhibidor #1



7844
Exhibidor #4



7846
Exhibidor #6

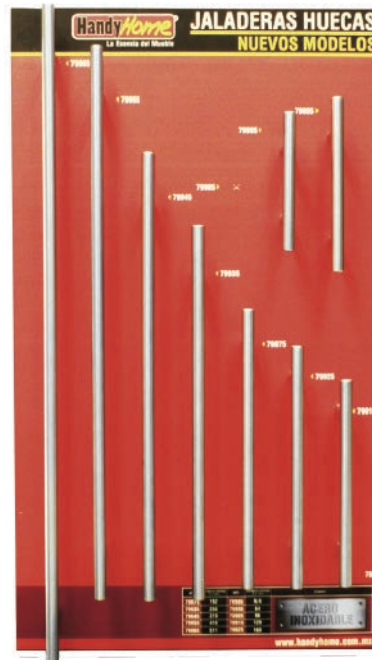

7863
Exhibidor #10



7847
Exhibidor #7

APOYO A MERCADOTECNIA

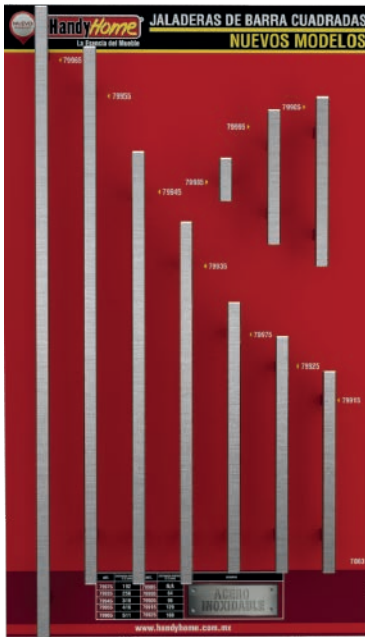

7867
Exhibidor #11



7864
Exhibidor #12



7865
Exhibidor #13



7875
Exhibidor #14



7855
Giratorio # 5

*Incluye 4 frentes a seleccionar entre jaladeras y herrajes.



3999
Totem Giratorio

*Incluye 12 frentes a seleccionar entre jaladeras y herrajes.



Síguenos en:





La Esencia del Mueble

MATRIZ MONTERREY

Modesto Alanís #2451 Col. Misión del Valle
Guadalupe, N.L. (Monterrey) México C.P. 67118
Tel. (81) 8000-0800

OFICINA VENTAS CIUDAD DE MÉXICO

Lope de la Vega # 117 Desp. 103
Col. Chapultepec Morales,
Delegación Miguel Hidalgo,
CDMX C.P. 11570
Tel. (55) 5203-8963

OFICINA VENTAS GUADALAJARA

Av. Mariano Otero # 3431 5to. Piso Of. 1
Col. Verde Valle,
Guadalajara, Jal. C.P. 44550
Tel. (33) 3121-5680



Impresión (1) 30-10-2022. Los catálogos y listas de precios pueden sufrir cambios sin previo aviso

CHAPA INDUSTRIAS S.A. DE C.V.

Tel. (81) 8000-0800 / ventas@chapaindustrias.com.mx

Síguenos en:

